

# SmartRipple Timer



## Product description

- The ESCOTEK Geyser Load Control Timer, SmartRipple timer, will prevent hot water cylinders (geysers) from switching on during Eskom designated peak times in the mornings and evenings on weekdays.
- The SmartRipple permits the user to easily select one of five operating schedules by pressing the Bypass button to select the operating times.
- The SmartRipple is locally designed and manufactured according to ISO9001:2000 standards.
- The SmartRipple has a successful track record, having been successfully installed in the Eskom NMBM and Ekurhuleni load management programmes.
- The SmartRipple has many features including a one hour override/bypass option outside of ESKOM peak times, with a default random soft pickup value of 15 minutes. The soft pickup is settable via IR, and can be specified by Eskom.
- The SmartRipple is supplied with a shroud for installation next to the Distribution Board where necessary.
- The SmartRipple has a Letter of Authority (LOA) from NRCS.

## Functionality

- The SmartRipple is simple and quick to install, either within the Distribution Board or next to the Distribution Board with a separate Shroud, which is supplied for the unit.
- Five easily selectable pre-programmed operating schedules to ensure maximum comfort whilst not burdening the user with the complicated process of having to programme the unit.
- The 5 schedules options include:
  - Schedule 1 : Default, always ON, outside peak times
  - Schedule 2 : Solar, ON after hours to accommodate solar geysers
  - Schedule 3 : Holiday, OFF all the time, holiday function
  - Schedule 4 : Eco 1 , ON 6 hours weekdays and 12 hours weekends.
  - Schedule 5 : Eco 2 , ON 6 hours weekdays and 8 hours weekends.
- The SmartRipple disconnects power to the geyser during ESKOM designated peak times and has a 60 minute bypass option to permit the user to power ON for 60 minutes at any time outside peak times.
- The SmartRipple features a Eskom settable 15 minute random soft pickup time.
- The SmartRipple has a 3 year warranty, subject to the manufacturer's standard terms and conditions.
- The control unit is sealed to avoid tampering or accidental changes to the timing algorithm.
- The SmartRipple is supplied with a clear and easy to use installation and user guide.
- The SmartRipple features a battery backup with a minimum lifespan of 10 years, maximum 18 years.
- The SmartRipple utilises an onboard real time clock for minimal time drift of less than 65 seconds/year.
- The SmartRipple has
  - Thermal protection on the terminals to prevent fires caused by loose connections.
  - Relay error indication.
  - Relay Bypass detection.
  - Input self resettable fuse protection.
- The SmartRipple key technical specifications:

- Supply voltage of 220-230 VAC, 50 Hz.
- Maximum load switching capacity of 20A @ 220 – 230 VAC, 50 Hz.
- Operating temperature range of -20 to +55°C.
- Power consumption is smaller than 1W.
- Width : 36 mm

### **Safety precautions**

- The installation of the SmartRipple must be done by a qualified electrician.
- Switch power off before installation.
- Make sure that the power wiring comes from a circuit with a maximum 20A circuit-breaker for short-circuit protection.
- The unit is designed to be fitted in existing distribution boards using DIN, Mini Rails and surface mounting.

### **Warning**

- No person may do electrical installation work as an electrical contractor unless that person has been registered as an electrical contractor in terms of clause 6 of the Electrical Installations Regulation, Occupational Health and Safety Act, 1993 (Act No. 85 of 1993)
- **Electrical connections must always be considered as energised irrespective of the LED indications.**

### **Specifications**

Input	: 220-230VAC 50 Hz
Current rating	: 20A AC maximum
Terminals	: 4 mm <sup>2</sup> conductor, torque 0.5 Nm
Power consumption	: < 1W
RTC Battery Back-up	: Minimum lifespan of 10 years, maximum 18 years.
RTC Drift	: < 65 seconds/year
Input protection	: Thermal and 500 mA self resettable fuse.
RTC and schedule programmable	: Infra Red (IR), handheld or PC/USB
Bypass/Override	: Green LED flashing.
Relay Status	: Relay ON : Green LED on : Relay OFF : Red LED on
Identification	: Unique serial number.
Programming	: Infra Red (IR) interface, handheld or PC/USB
Schedule	: Flashing Blue LED : Schedule 1: Default : 1 flash : Schedule 2: Solar : 2 flashes : Schedule 3: Holiday : 3 flashes : Schedule 4: Eco 1 : 4 flashes : Schedule 5: Eco 2 : 5 flashes
Mounting	: DIN, Mini, Surface mount
NRCS certification	: Letter of Authority
IEC	: IEC 60669-1:1998, IEC 60669-2-2:2006 : IEC 60950-1:2001, SANS 60950-1:2003

### **Mounting location**

The SmartRipple unit is designed to be mounted inside existing distribution boards using DIN, Mini Rails and surface mounted if distribution board mount is not possible. Alternatively, where there is inadequate space within the distribution board, the unit can be mounted next to the distribution board with the supplied DIN rail and shroud.

- Surface mount - mounting location inside roof cavity (ceiling) close to the geyser isolator. The SmartRipple is to be fitted on a DIN Rail and attached to the wood rafters with screws.
- DIN, Mini Rail mounting – mounting location inside existing electrical distribution board.

**Note that it is the responsibility of the installer to ensure that the installation of this unit meets the minimum requirements to obtain the necessary Certificate of Compliance.**

### *Installation*

To facilitate the installation of the SmartRipple, the following tools/accessories are essential:

**Surface mount**

- Electric/Cordless drill and drill bit;
- Phillips/Flat Screwdriver;
- Wood screws;
- Measuring tape;
- Permanent Marker.

**Din Rail mount – inside distribution box**

- Phillips/Flat Screwdriver.

Select the proper mounting locations for mounting the SmartRipple as per section on mounting location.

### *Wiring*

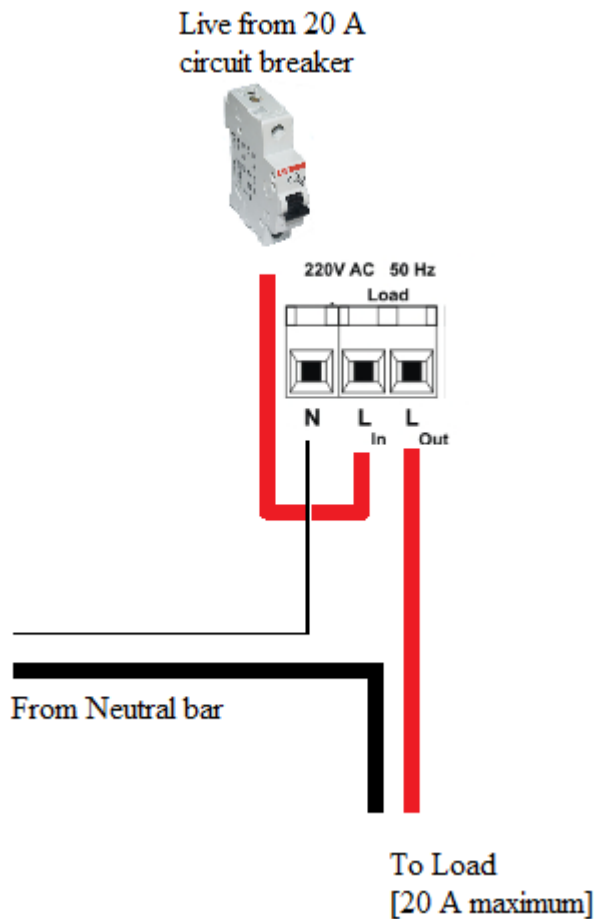

Figure 1

### **Led indications: normal conditions**

 **Blue LED** : Flashing: indicating schedule– **Correct.**

: Any other state:

- First check that the circuit breaker is ON.
- Contact the electricity supplier.

 **Red LED:**

- OFF : Relay is OFF – **Correct.**

 **Green LED:**

- ON : Relay is ON and there is an output voltage on the terminals – **Correct**
- Flashing : Bypass function has been activated -**Correct**

 **Red & Green LED:**

- Flashing fast: Relay is OFF and in soft pickup mode. Usually after power failure - **Correct**

### **Led indications: Fault conditions**

 **Red & Green LED** : Both solid **ON**: Relay failure, switch circuit breaker off and contact the electricity supplier.

 **Red LED** : Flashing, Over Temperature. Faulty installation, switch circuit breaker off and contact the electricity supplier.

### **Surface mount installation instructions**

1. Turn OFF main circuit breaker inside master DB (inside house).
2. Turn OFF geyser isolator
3. SmartRipple surface mount installation;
  - a. Select proper mounting location in ceiling cavity;
  - b. Use DIN Rails supplied , demarcate mounting holes ;
  - c. Mount DIN Rail, inside ceiling cavity with wood screws to wood rafters close to geyser isolator;
  - d. Secure SmartRipple on DIN Rail.
4. SmartRipple Wiring Surface mount - Mains Power 220-240VAC ~50Hz;
  - a. Mains live wire (RED) from Geyser Isolator to screw terminal (Figure 1 - Lin);
  - b. Neutral wire (Black) from Geyser Isolator to screw terminal (Figure 1 - N).
5. SmartRipple Wiring Surface Mount - Timer Controller output to geyser;
  - a. Live wire (RED) from geyser to screw terminal (Figure 1 - Lout);
  - b. Neutral wire (Black) from geyser to screw terminal (Figure 1- N);
6. Ensure SmartRipple is installed correctly.
7. Turn on main circuit breaker, from master DB (inside house).
8. Select preferred schedule for operation.

### **Distribution board installation instructions**

1. Turn OFF main circuit breaker inside master DB (inside house).
2. Install SmartRipple;
  - a. Select proper mounting location inside new or existing distribution panel;
  - b. Secure SmartRipple on DIN Rail;
3. SmartRipple Wiring DB mount - Mains Power 220-240VAC ~50Hz;
  - a. Mains live wire (RED) from geyser breaker to screw terminal Lin (Figure 1 - Lin);
  - b. Neutral wire (Black/Blue) from Neutral Bar to screw terminal N (Figure 1 - N).

4. SmartRipple Wiring DB Mount - Timer Controller output to geyser;
  - a. Live wire (RED) from geyser isolator to screw terminal Lout (Figure 1 - Lout);
  - b. Neutral wire (Black) from geyser isolator to neutral bar (standard wiring);
5. Ensure SmartRipple is installed correctly.
7. Turn on main circuit breaker, from master DB (inside house).
8. Select preferred schedule for operation.

### **Operation instructions**

#### **SmartRipple timer (Geyser) operation**

- Ensure SmartRipple is installed correctly.
- Ensure all mains power connectors and covers are properly closed and secured.
- Ensure mains power is restored.
- Verify Mains power status, green LED light is **ON**.
- Verify Geyser status, red LED light **OFF/ON**.
- Verify SmartRipple Schedule status blue flashing LED.

#### **SmartRipple timer Schedule Selection**

- Verify SmartRipple programme status blue flashing LED.
- Select preferred schedule.
- Change schedule by depressing Bypass Button with a single short (< 0,5 sec) press to move programme selection up one level, e.g., blue light flash once, single fast depress will move programme to level 2, blue light flashes twice etc.
- Continue schedule selection by depressing bypass button until correct schedule is obtained;
  - Schedule 1 – Flashing Blue LED status light: 1 flash : Default, always in “ON” mode but “OFF” during designated peak times (Red) below (Weekdays). Bypass “ON” option may be selected at any time excluding designated peak times.
  - Schedule 2 – Flashing Blue LED status light: 2 flashes: “OFF” from 08h00 to 15h00 and “OFF” for designated peak times (Red) below Weekdays) Bypass “ON” option may be selected at any time excluding designated peak times. This programme is suitable for solar geyser applications.
  - Schedule 3 – Flashing Blue LED status light: 3 flashes: “OFF” all the time. Bypass “ON” option may be selected at any time excluding designated peak times (Red) below (Weekdays). This programme is suitable for solar geyser applications or when on holiday.
  - Schedule 4 – Flashing Blue LED status light, 4 flashes : “OFF” from 00h00 to 03h00, from 08h00 to 15h00, from 20h00 to 24h00 and for designated peak times (Red) below (Weekdays). Note that Weekends there is an additional “ON” time from 11h00 to 13h00. Bypass “ON” option may be selected at any time excluding designated peak times.
  - Schedule 5 – Flashing Blue LED status light, 5 : “OFF” from 00h00 to 03h00, from 08h00 to 15h00, from 20h00 to 24h00 and for designated peak times (Red) below (Weekdays). Bypass “ON” option may be selected at any time excluding designated peak times.

#### **SmartRipple Timer Bypass Function**

SmartRipple module is fitted with a 1 Hour Bypass function to allow geyser status control for the following:

- Manual user control, heating cold geyser for duration 1 hour.
- Depressing the bypass button (greater or equal to 1 second) on the SmartRipple will change Geyser Status to “ON” mode, normal thermostat control for the duration of 1 hour outside designated peak times.

#### **Notes**

- The SmartRipple will power “OFF” the geyser before peak time and before profile “OFF” time by between 0 and 15 minutes, this time determined randomly, and will Power “ON” the geyser after peak time and after Profile “ON” by between 0 and 15 minutes, this time is determined randomly. Following a power outage, the SmartRipple will remain “OFF” for duration of maximum of 15 minutes soft pickup, this time is determined randomly. The default 15 minutes soft pickup can be adjusted by Eskom if required.

➤ **WARNING**

*Do not dispose of electrical appliances as unsorted municipal waste. Use separate collection facilities. Contact your local government for information regarding the collection systems available. If electrical appliances are disposed of in landfills or dump, hazardous substances can leak into the groundwater and get into the food chain, damage your health and well being. When replacing old appliances with new, the retailer is legally obligated to take back your old appliance for disposal free of charge.*

#### Escotek Contact Details

Physical Address:	430 Muskejaat Street Waterkloof Ridge Pretoria, 0181, Gauteng, South Africa		
Postal Address:	Post Net Suite 21 P/Bag X25723 Monument Park Pretoria, 0105, Gauteng, South Africa		
Telephone Number:	+27 12-347 7034	Fax Number:	+27 12-347 5352
Web page:	<a href="http://www.escotek.co.za">www.escotek.co.za</a>	Email:	<a href="mailto:marketing@escotek.co.za">marketing@escotek.co.za</a>

#### Warranty

Escotek (Pty) Ltd ("ESCOTEK") use quality components and skilled workmanship and are prepared to issue a Warranty in connection with the products that we produce. The terms of our Warranty include the replacement of any ESCOTEK manufactured product found to be effective insofar as such defect arising from the production process, and confirmed by ESCOTEK to have so occurred. The duration of the Warranty is for a period of a full 3 years from the date of purchase, but excludes the removal of any defective (or allegedly defective) product and/or the installation of replacement product or costs associated thereto. Standard commercial practice and insurance prescriptions dictate that excluded from our Warranty is any misuse, neglect, alteration to, lightning strikes (whether upon, above, beneath the ESCOTEK product or any receptacle housing the ESCOTEK product), sub-optimal installation or physical damage to our products arising from any cause whatsoever.

#### Reference guide

- This SmartRipple allows the user to select one of five operating programmes as illustrated below.
- Each programme provides different electrical power "ON" times to the geyser. Note, during the electrical power "ON" times the geyser will only switch on and heat water when required to do so by the geyser thermostat.
- The user may select the Bypass "ON" option to power "ON" the geyser for up to 60 minutes to heat water as required. Note; this option is NOT available during designated peak times.
- The SmartRipple has been pre-programmed to switch off electrical supply to the geyser during the designated peak times, Weekdays 06H00 to 08H00 and 18H00 to 20H00. The user may not override or alter these peak times.

#### Schedule Selection

Select required programme by pressing "Bypass" button with a single one second press to move schedule selection up one level, blue LED flashes once, single press will move schedule to level 2, blue light flashes twice etc, until the correct schedule is obtained.

### Schedule 1 (Default)

Blue LED flash : 1 flash  
 ON : Weekdays - outside peak times, Weekends – always ON.  
 OFF : Weekdays - peak times.  
 Bypass : not applicable.

#### Weekdays

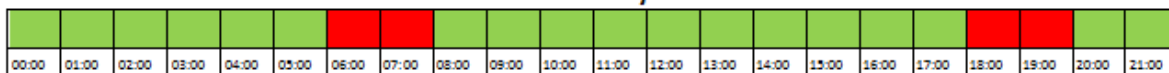

#### Weekends

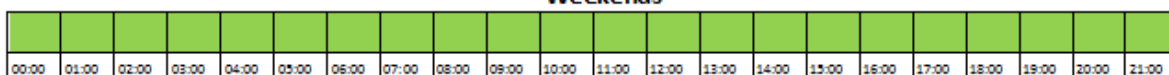

- 06H00 to 08:00, 18:00 to 20:00, Geyser electrical power is OFF
- Geyser electrical power is OFF, Bypass can be used.
- Geyser electrical power is ON, geyser thermostat in control.

### Schedule 2 (Solar)

Blue LED flash : 2 flashes  
 ON : outside peak times (morning and evening Monday to Friday).  
 OFF : peak times.  
 Bypass : option may be selected at any time excluding designated peak times.

#### Weekdays

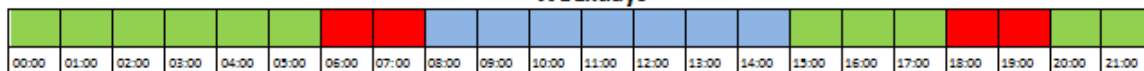

#### Weekends

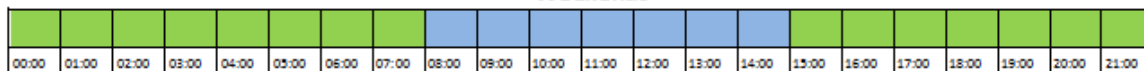

- 06H00 to 08:00, 18:00 to 20:00, Geyser electrical power is OFF
- 08H00 to 15H00, Geyser electrical power is OFF, Bypass can be used.
- Geyser electrical power is ON, geyser thermostat in control.

### Schedule 3 (Holiday/On demand)

Blue LED flash : 3 flashes  
 ON : outside peak times (morning and evening Monday to Friday).  
 OFF : peak times.  
 Bypass : option may be selected at any time excluding designated peak times.

#### Weekdays

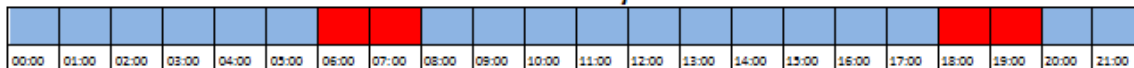

#### Weekends

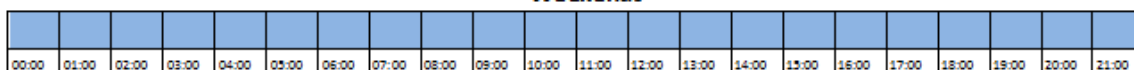

- 06H00 to 08:00, 18:00 to 20:00, Geyser electrical power is OFF
- Geyser electrical power is OFF, Bypass can be used.
- Geyser electrical power is ON, geyser thermostat in control.

**Schedule 4 (Eco 1)**

- Blue LED flash : 4 flashes
- ON : outside peak times (morning and evening Monday to Friday).
- OFF : peak times.
- Bypass : option may be selected at any time excluding designated peak times.

**Weekdays**

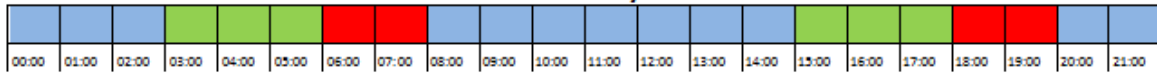

**Weekends**

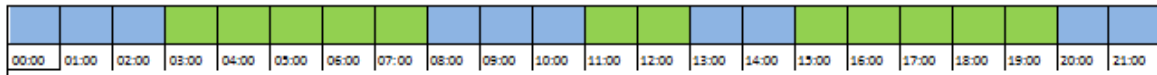

- 06H00 to 08:00, 18:00 to 20:00, Geyser electrical power is OFF
- Geyser electrical power is OFF, Bypass can be used.
- Geyser electrical power is ON, geyser thermostat in control.

**Schedule 5 (Eco 2)**

- Blue LED flash : 5 flashes
- ON : outside peak times (morning and evening Monday to Friday).
- OFF : peak times.
- Bypass : option may be selected at any time excluding designated peak times.

**Weekdays**

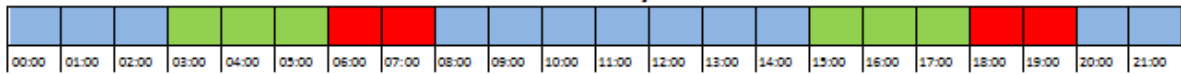

**Weekends**

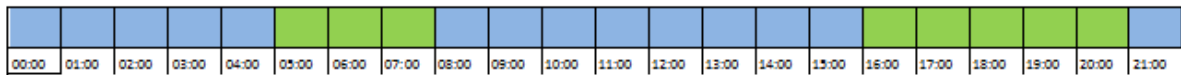

- 06H00 to 08:00, 18:00 to 20:00, Geyser electrical power is OFF
- Geyser electrical power is OFF, Bypass can be used.
- Geyser electrical power is ON, geyser thermostat in control.

**End**